

AERO®

Tracheobronchial Stent Technology System

 Review Instructions For Use Before Using This System.

 Single Use

 Non-sterile

 MR Conditional

CONTENTS

Instructions For Use3

IMPORTANT PRODUCT INFORMATION

Please read this information carefully before using the MERIT ENDOTEK™ AERO® Tracheobronchial Stent Technology System. Failure to properly follow the instructions may result in serious clinical consequences.

CAUTION: Federal law (USA) restricts this device to sale by or on order of a physician.



Manufacturer
Merit Medical Systems, Inc.
South Jordan, Utah 84095 U.S.A. 1-801-253-1600
U.S.A. Customer Service 1-800-356-3748

US and foreign patents issued and pending

AERO® is a trademark of MERIT ENDOTEK™



DEVICE DESCRIPTION

The **MERIT ENDOTEK™ AERO® Tracheobronchial Stent System** is comprised of two components: the radiopaque self-expanding nitinol stent and the delivery system. The stent is completely covered with a biocompatible polyurethane membrane. The stent expansion results from the mechanical properties of the metal and the proprietary geometry. The stent is designed with a slightly larger diameter near the distal and proximal ends to minimize the possibility of migration. The stent ends are slightly vaulted inwardly in order to minimize possible airway injury from the stent edges. The overall stent geometry is designed to maintain a constant length over the entire range of possible diameters. As a result of this unique design the stent has virtually no foreshortening, thus facilitating the selection of the appropriate stent length.

The stents are deployed with a dedicated delivery system. The delivery system consists of two coaxial sheaths. The exterior sheath serves to constrain the stent until the sheath is retracted during deployment. The stent remains constrained by the delivery system until it is deployed beyond the indicator marker (approximately 50% of its length). This feature allows for repositioning of the stent proximally. In addition, the procedure can be aborted and the entire system can be withdrawn en bloc at any time before the stent has been deployed beyond 50% of its length. A radiopaque tip and marker on the inner shaft aid the operator in determining stent position in relation to the deployment threshold, where repositioning or *en bloc* withdrawal is no longer possible. The inner tube of the coaxial sheath catheter contains a central lumen that will accommodate a 0.035" guide wire. This feature is designed to allow safe guidance of the delivery system to the intended implant site while minimizing the risk of airway injury from the delivery system tip.

The stent and delivery system are provided non-sterile. For user sterilization information, see the section in these Instructions for use, headed **Sterilization Information**. The complete Instructions for use should be reviewed before using this system.

Non-clinical testing has demonstrated that the AERO® Tracheobronchial Stent is MR Conditional. It can be scanned safely under the following conditions:

- Static magnetic field of 3-tesla or less
- Spatial gradient field of 720 Gauss/cm or less
- Maximum specific absorption rate (SAR) of 3 W/kg for 15 minutes of scanning.

In non-clinical testing, the **AERO® Tracheobronchial Stent System** produced a temperature rise of less than 0.6°C at a maximum specific absorption rate (SAR) of 3 W/kg for 15 minutes of MR scanning in a 3-tesla MR system using a transmit/receive body coil (excite, Software G3.0-052B,

General Electric Healthcare, Milwaukee, WI) MR scanner. MR image quality may be compromised if the area of interest is in the exact same area or relatively close to the position of the AERO® stent. Therefore, it may be necessary to optimize MR imaging parameters for the presence of this metallic implant.

INDICATIONS FOR USE

The **MERIT ENDOTEK™ AERO® Tracheobronchial Stent System** is indicated for use in the treatment of tracheobronchial strictures produced by malignant neoplasms.

WARNING: The safety and effectiveness of the device for use in the vascular system has not been established and can result in severe harm and/or death.

CONTRAINDICATIONS

The **MERIT ENDOTEK™ AERO® Tracheobronchial Stent System** is contraindicated for:

1. Tracheobronchial obstruction with a luminal diameter that cannot be dilated to at least 75% of the nominal diameter of the selected stent.
2. Patients for whom bronchoscopic procedures are contraindicated.
3. Any use other than those specifically outlined under Indications for Use.

POTENTIAL COMPLICATIONS

Complications have been reported in the literature for tracheobronchial stent placement with both silicone stents and expandable metal stents. These include, but are not necessarily limited to:

PROCEDURAL COMPLICATIONS:

- Stent misplacement
- Bleeding
- Tracheobronchial perforation and pneumothorax
- Retrosternal Pain
- Aspiration
- Hypoxia
- Infection

POST-STENT PLACEMENT COMPLICATIONS:

- Stent migration
- Occlusion due to mucous accumulation
- Occlusion due to tumor in-growth or overgrowth at stent ends
- Occlusion due to granulomatous tissue formation
- Chronic cough
- Partial stent fractures

- Recurrent obstructive dyspnea related to stent occlusion or migration
- Tracheobronchial wall ulceration, perforation and hemorrhage
- Infection and septic shock
- Aphonia
- Death

ADDITIONAL CAUTIONS AND WARNINGS

1. The **MERIT ENDOTEK™ AERO® Tracheobronchial Stent Technology System** should be used with caution and only after careful consideration in patients with:

- Extended clotting times or coagulopathies
- Prior pneumonectomy
- Active acute inflammation in the airway lumen
- A tumor related stenosis adjacent to a major vessel

2. If the stent becomes fractured or does not fully expand during implantation, remove the stent following the Instructions for use.

3. Do not use the stent for treatment of lesions where placement of the device may obstruct a functioning major sidebranch.

4. Do not cut the stent or the delivery catheter. The device should only be placed and deployed using the supplied catheter system.

5. Do not use a kinked bronchoscope, endotracheal tube or introducer sheath as this may increase the force necessary to deploy the device and may cause a deployment failure or catheter breakage.

6. Do not deploy the stent inside of the bronchoscope.

7. Do not reposition the stent by pushing on the stent with the bronchoscope.

8. Do not insert a rigid bronchoscope through the stent lumen after deployment.

9. When using a rigid bronchoscope, do not allow the bronchoscope to abrade the stent.

10. Do not withdraw the **MERIT ENDOTEK™ AERO® Tracheobronchial Stent System** back into the bronchoscope, endotracheal tube, or introducer sheath once the device is fully introduced. Withdrawing the stent back into the bronchoscope, endotracheal tube, or introducer sheath may cause damage to the device, premature deployment, deployment failure, and/or catheter separation. If removal prior to deployment is necessary, do not reuse the stent or delivery device.

11. Do not reposition the stent by grasping the polyurethane covering. Always grasp the stent connector to reposition the stent and do not twist or rotate the stent or metal strut unless the stent is being removed.

12. If the lesion mass is reduced significantly, (as may occur with radiation therapy or chemotherapy) there is an increased chance of migration. If this occurs, removal of the stent should be considered.

13. There is an increased risk of stent migration when the stent has been implanted in patients with narrowing at the distal end of the lesion relative to the proximal end (conical

STENT DIAMETER SIZING TABLE (TABLE 1)

DEVICE SIZING	
Labeled Device Diameter (mm)	Recommended Lumen Diameter (mm) (1)
10	7.5-9.5
12	9.0-11.5
14	10.5-13.5
16	12.0-15.5
18	13.5-17.5
20	15.0-19.5

STENT DIAMETER SIZING TABLE (TABLE 2)

DEVICE SIZING					
	Labled Length 20mm	Labled Length 30mm	Labled Length 40mm	Labled Length 60mm	Labled Length 80mm
Labeled Device Diameter (mm)	Stenosis Length (mm)				
10	5.7	15.7	25.7	N/A	N/A
12	5.7	15.7	25.7	N/A	N/A
14	5.7	15.7	25.7	N/A	N/A
16	N/A	N/A	21.4	41.3	61.2
18	N/A	N/A	22	42	62.3
20	N/A	N/A	22.5	38.2	59.2

or funnel shaped lesion). Physicians should consider monitoring these patients for up to 72 hours after stent placement and may wish to verify final placement using chest x-ray.

STENT SELECTION

- Prior to implantation of the **MERIT ENDOTEK™ AERO® Tracheobronchial Stent System**, the physician should refer to the Sizing Table (Table 1) on the previous pages and read the Instructions for Use.
- When used in the treatment of stenotic or obstructive lesions, placement of the stent should immediately follow the opening of the airway by whatever means appropriate and be confirmed by fluoroscopy and/or bronchoscopy. The device must be sized in accordance with the Sizing Table (Table 1) using accurate measurement techniques.
- Proper placement of the device should be monitored and confirmed using bronchoscopy and/or fluoroscopy.

INSTRUCTIONS FOR USE

MERIT ENDOTEK™ recommends that the operator follow the directions outlined below.

1. Locate Stenosis and Pre-Dilate as Necessary.

Pass a bronchoscope into the airway beyond the tracheobronchial stricture. If necessary, dilate the stricture using a balloon catheter dilator until a bronchoscope can be passed.

When selecting a rigid tube for placement of the device with rigid bronchoscopy select a tracheal tube that has an internal diameter of not less than 11.5mm to allow sufficient clearance for the delivery system and a flexible or rigid bronchoscope. The physician should confirm that there is adequate clearance before proceeding with the stent placement.

WARNING: Do not attempt placement of the **MERIT ENDOTEK™ AERO® Tracheobronchial Stent System** in patients with stenoses that cannot be dilated sufficiently to allow passage of a bronchoscope.

2. Estimate the Stenosis Length and Luminal Diameter.

This estimation may be performed by visual inspection via bronchoscopy or via fluoroscopy.

Measuring the length: Advance the scope to the distal end of the lesion, pause and observe the anatomy. Once familiar with the landmark of the distal end of the lesion advance the scope an additional 5mm. (If there are measurement markers on the scope they can be used to verify this length) Grasp the proximal end of the

scope and do not release your grasp. Retract the scope until the proximal end of the lesion can be visualized. Continue retracting the scope until it is positioned 5 mm proximal to the lesion site. With your opposite hand grasp the proximal end of the scope near the patient's mouth while maintaining your initial grip. It is important to always maintain the initial grasp mark on the scope during visual measurement because this will provide you with the initial point of reference to conduct the length measurement. Once the distal and proximal limits are identified it is possible to measure the lesion length and select the appropriate size stent. (If there are depth measurement markings on the scope these can be used to measure the actual lesion length.) Once the measurement is completed the appropriate length stent can be selected. (Be sure to review the directions for use regarding sizing the diameter before choosing the final device). To determine the lumen diameter, estimate the diameter of the normal-appearing tracheobronchial lumen proximal to the stenosis. An open biopsy forceps may be used for a reference guide. Alternatively, the stenosis length and luminal diameter may be measured by reviewing a recent CT Scan of the narrowed tracheobronchial lumen.

3. Identify Landmarks to Aid in Placement.

Bronchoscopically examine the lumen distal to the stenosis, noting the distance to any branches. Examine the stenotic area fluoroscopically. The stricture should be dilated to approximately 75% of the normal lumen diameter. Radiopaque markers may be placed on the patient's chest to assist in identifying the margins of the stenotic area.

4. Select the Appropriate Covered Stent Size.

Choose a stent long enough to completely bridge the target stenosis with a 5mm margin both proximally and distally. Choose the stent diameter to approximate the size of the normal proximal lumen but do not exceed the desired final diameter by more than 2mm. If possible, avoid choosing a stent that would cross side branches when placed. See Sizing Table (Table 1).

5. Introduce the Guide Wire.

Place a 0.035" (0.89mm), stiff-bodied, soft-tipped guide wire through the bronchoscope and beyond the stenosis. The bronchoscope should be removed at this time while maintaining the position of the guide wire.

6. Inspect and prepare the AERO® Tracheobronchial Stent System.

This product is supplied non-sterile. Before opening the package, inspect the package for damage. Do not use if the package has been opened or damaged. Visually inspect the Tracheobronchial Stent Technology System for any sign of damage. Do not use if it has any visible signs of damage.

Lubricate the distal portion of the stent delivery catheter with water-soluble lubricant to aid in introduction. Backload the guide wire into the distal end of the delivery system.

7. Positioning of AERO® Tracheobronchial Stent System in Airway.

Under bronchoscopic visualization, advance the stent over the guide wire through the stenosis. Direct visualization of the green proximal marker on the delivery device will provide a guide for placement. The proximal end of the deployed stent will be aligned with this green marker. When using fluoroscopy, visualize the radiopaque markers on the delivery system tip and inner shaft so that the stenosis is centered between them. These markers indicate the ends of the stent. The stent will not foreshorten upon deployment.

8. Deployment of 60mm and shorter in length.

Hold the hand grip in the palm of your hand (Fig. 1). Using the index and middle finger, grasp the deployment handle.

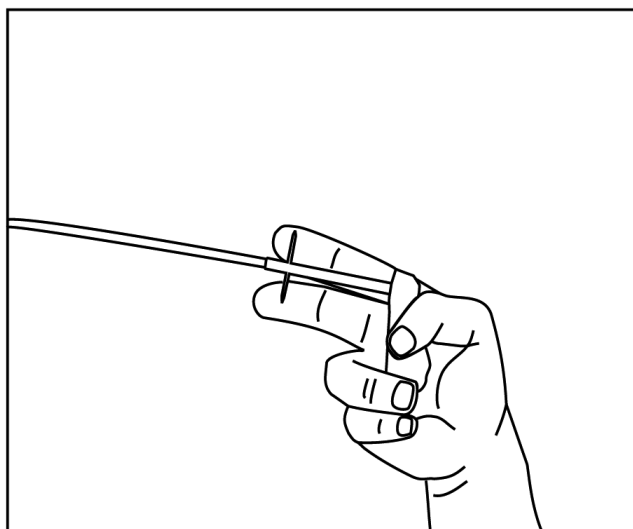

Figure 1.

Slowly retract the outer sheath by pulling back on the deployment handle (Fig. 2) until the deployment handle touches the hand grip. The stent is now fully deployed. Carefully remove the delivery system without disturbing the position of the stent.

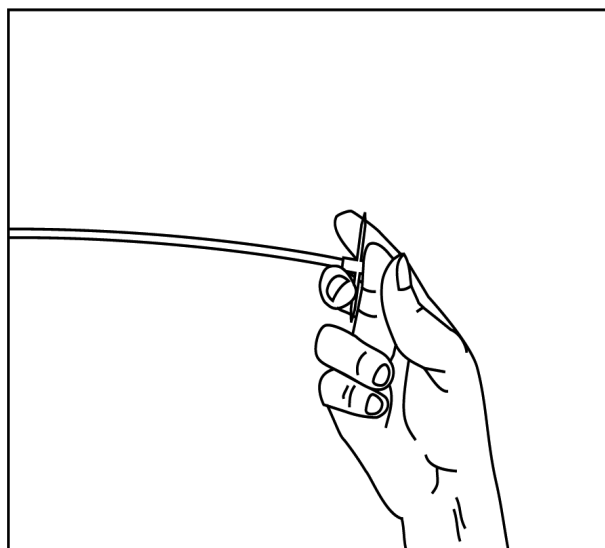

Figure 2.

Monitor the stent deployment under fluoroscopy, while maintaining the identified stricture margins centered between the delivery system radiopaque markers. If necessary, stop deployment and adjust the stent position proximally. The stent may be repositioned proximally while holding the position of the deployment handle and moving the delivery system as a unit. The stent may be repositioned proximally until it has been deployed to approximately 50% of its length.

9. Deployment of stents longer than 60mm.

The delivery device for stents greater than 60mm in length has two deployment handles to allow the user to deploy the stent in two steps (Fig. 3).

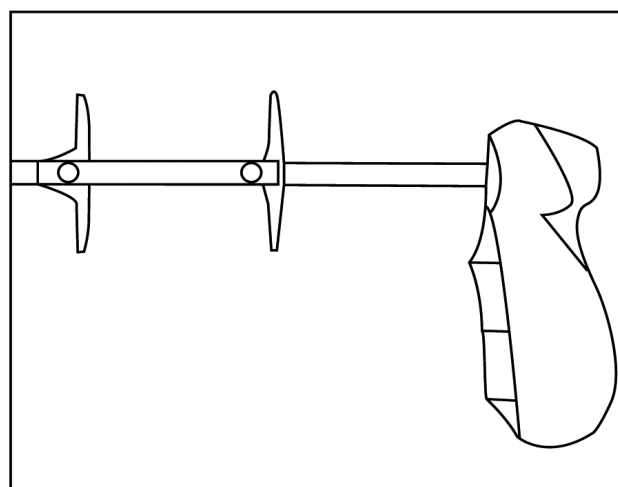

Figure 3.

Hold the hand grip in the palm of your hand (Fig. 4). Using the index and middle finger, grasp the first deployment handle.

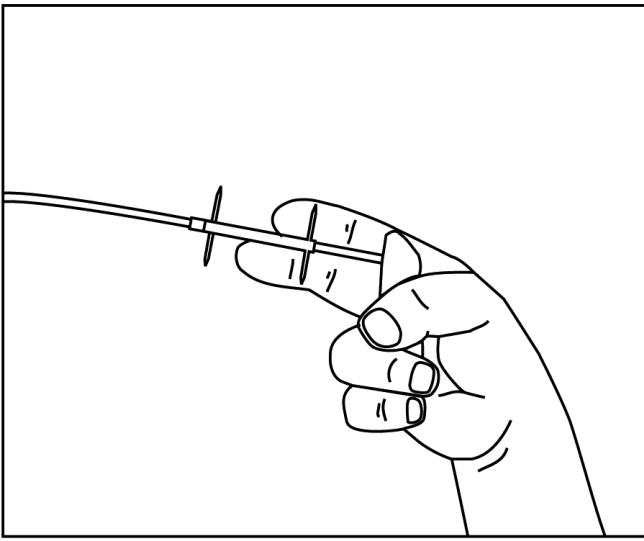

Figure 4.

Slowly retract the outer sheath by pulling back on the first deployment handle until the deployment handle touches the proximal handle (Fig. 5). (Slowly pull back on the outer sheath during deployment. This will provide tactile feedback as the stent deploys. It is recommended to keep your elbow stationary and close to your body during deployment.)

The stent is now partially deployed. The stent may be repositioned proximally while holding the position of the deployment handle and moving the delivery system as a unit. The stent may be repositioned proximally until it has been deployed to approximately 50% of its length.

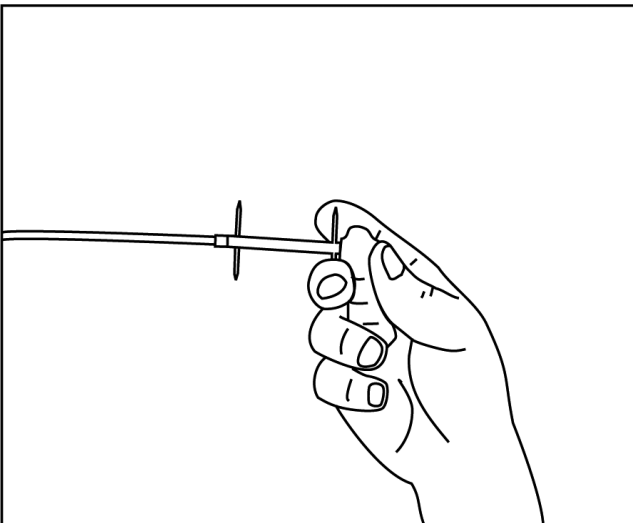

Figure 5.

After confirming the position of the stent use your index and middle finger to grasp the second deployment handle (Fig. 6)

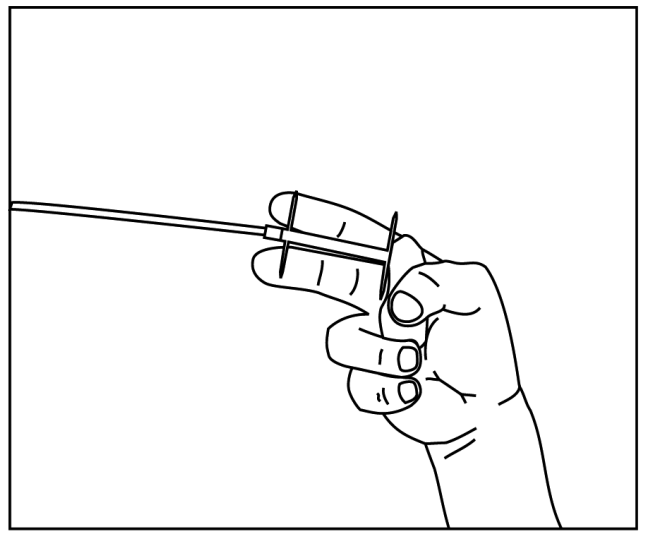

Figure 6.

Pull the second deployment handle until the handle touches the hand grip (Fig. 7). The stent is now fully deployed. Carefully remove the delivery system without disturbing the position of the stent.

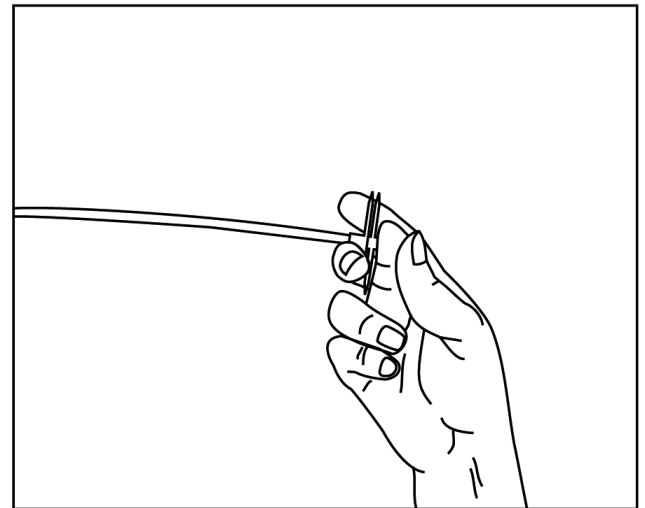

Figure 7.

10. Assess Deployed Stent and Remove Delivery System.

Confirm bronchoscopically and fluoroscopically that the stent has completely deployed and expanded. Carefully remove the delivery catheter from within the expanded stent, using care not to move the stent with the distal tip of the delivery system. If the stent appears to be damaged or is not evenly and fully deployed, it should be removed following the directions for use to remove the stent. Dilation is not recommended.

WARNING: Conservative medical practice suggests that stents not be repositioned distally. Do not attempt to reload or reconstrain a deployed or partially deployed self-expanding stent. If it becomes necessary to remove a partially deployed stent the entire system should be withdrawn en bloc. Do not attempt to advance the outer sheath.

REMOVAL & REPOSITIONING OF THE TRACHEOBRONCHIAL STENT

The MERIT ENDOTEK™ stent can be repositioned or removed using grasping forceps. For removal of the stent, long-jawed forceps such as alligator or rat-tooth forceps are recommended. For repositioning the stent proximally, only an atraumatic grasper, such as alligator forceps, should be used. Do not use rat tooth or biopsy forceps (duck-billed forceps) to reposition the stent. Open the forceps and carefully pass the forceps over the end of the stent at the location of one of stent connectors. One jaw should be positioned outside of the stent, between the stent and the luminal wall. The other jaw should be positioned inside of the stent. Close the forceps over the stent connector, grasping as much of the stent connector as possible. Do not grasp the cover of the stent. Gently rotate the forceps one quarter of a turn as traction is applied. Slowly extract the stent. Use this technique for stent removal only. Do not rotate the stent if it is being repositioned proximally.

For a stent with a repositioning aid (blue colored braided suture) the Alveolus stent can be removed with an atraumatic forceps by grasping the suture adjacent to the knot and carefully applying traction. This will relieve tension on the proximal end of the stent, thus facilitating removal.

CAUTION: If the suture is used to reposition the stent proximally, the stent should be examined carefully to assure that it has fully expanded after repositioning. In the event that some compression remains at the proximal end it may be necessary to expand the stent with a balloon catheter.

WARNING: Clinical data for stent removal in humans was limited to a clinical study of 51 patients with malignancies. Thirteen devices were removed after 30 days; 6 devices were removed after 60 days; and 2 devices were removed after 90 days. During this clinical study, there was no tissue in-growth into the lumen of the stent reported.

PACKAGING AND LABELING

Inspect the **MERIT ENDOTEK™ AERO® Tracheobronchial Stent System** and the packaging for damage prior to use. Confirm that the device is consistent with the package label. Discard and replace any damaged devices.

DO NOT ATTEMPT TO REPAIR.

Contact MERIT ENDOTEK™ Customer Service at 1-800-356-3748 if the package has been opened or damaged.

STORAGE

Do not expose this device to conditions of extreme heat and humidity. Store the **MERIT ENDOTEK™ Tracheobronchial Stent System** in a normal room temperature environment.

HOW SUPPLIED

The disposable, single-patient-use self-expanding stents are available, pre-mounted on the delivery system in a variety of configurations.

WARNING: The **MERIT ENDOTEK™ Tracheobronchial Stent System** is provided non-sterile.

Each packaged unit is intended for **SINGLE-PATIENT-USE ONLY**.

STERILIZATION INFORMATION

If the user facility desires to sterilize the device prior to use the following information should be used as guidance.

Preconditioning Exposure parameters:

100° ± 10° F at 50% RH for 20 hours minimum

Maximum time between pre-conditioning and sterilization equals 30 minutes

EtO Process Cycle Parameters:

100% EtO for 10 hours minimum at 600 – 650 mg/L (to achieve 11" Hg. Pressure rise)

Product temperature monitored at 140° F maximum

Post Process Aeration:

110° ± 10° F at ambient RH for 24 hours minimum

This sterilization process has been validated using the halfcycle method in conformance with ANSI/AAMI/ISO 11135:1994 by MERIT ENDOTEK™ to provide a SAL of 10⁻⁶. Proper aeration will result in EtO residuals, ECH residuals and EG residuals below those required by ISO 10993-7. Because Alveolus cannot assure proper calibration and validation of the user equipment and process, sterility is the responsibility of the user.

DO NOT RESTERILIZE

For more information or to arrange for a demonstration, contact MERIT ENDOTEK™ at 1-800-356-3748.

WARRANTY

The manufacturer warrants that reasonable care has been used in the design and manufacture of this device. This warranty is in lieu of and excludes all other warranties not expressly set forth herein, whether expressed or implied by operation of law or otherwise, including, but not limited to, any implied warranties of merchantability or fitness. Handling and storage of this device, as well as other factors relating to the patient, diagnosis, treatment, implant procedures, and other matters beyond the control of the manufacturer directly affect the device and the results obtained from its use. The manufacturer obligation under this warranty is limited to the replacement of this device; and the manufacturer shall not be liable for any incidental or consequential loss, damage, or expense directly or indirectly arising from the use of this device. The manufacturer neither assumes, nor authorizes any other person to assume for it, any other or additional liability or responsibility in connection with this device. The manufacturer assumes no liability with respect to devices that are reused, reprocessed, or resterilized, and makes no warranties, expressed or implied, including, but not limited to, merchantability or fitness for intended use, with respect to such device.